

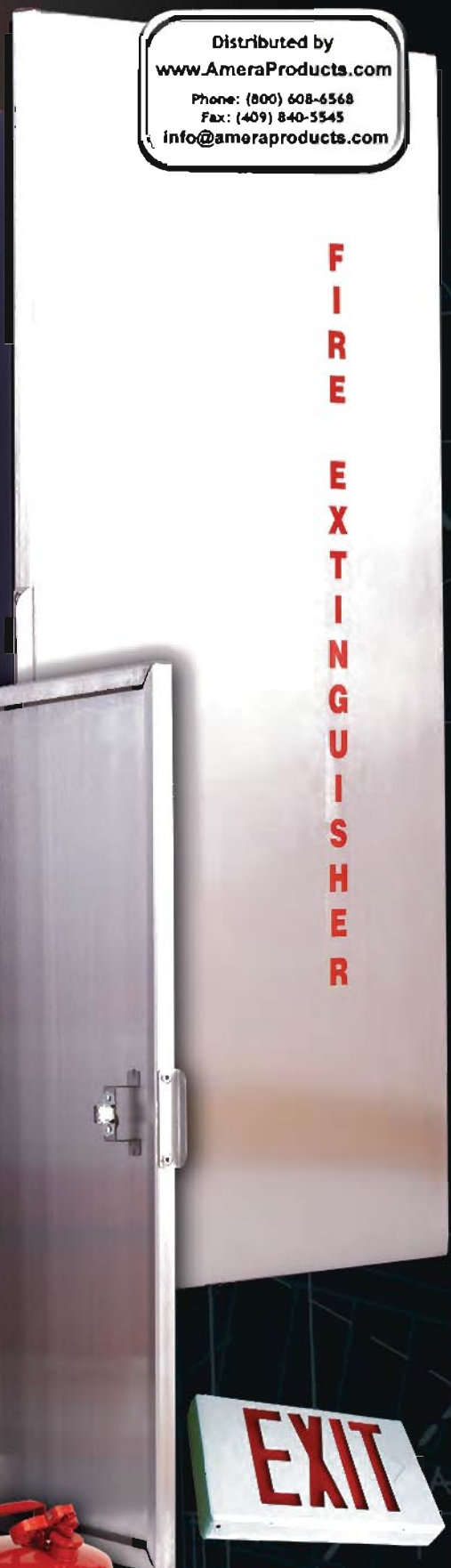

**Strike First
Corporation of
America**

Distributed by
www.Ameraproducts.com
Phone: (800) 608-6568
Fax: (409) 840-5345
info@ameraproducts.com



**Fire Extinguisher Cabinets
ABC & CO2 Fire Extinguishers
Safety Protection Products**

HDOC-Heavy Duty Outdoor Cabinet

Heavy Duty Outdoor Cabinet (HDOC) is made from 16 gauge galvanized steel in a baked red acrylic enamel over phosphate treated steel. It includes weather resistive gasketing, full length stainless steel piano hinge with 2 roller ball catches, safety lock, a sloped roof to facilitate drainage, white "Fire Extinguisher" decal, "Pull Firmly to Open" decal, and stainless steel pull handle.

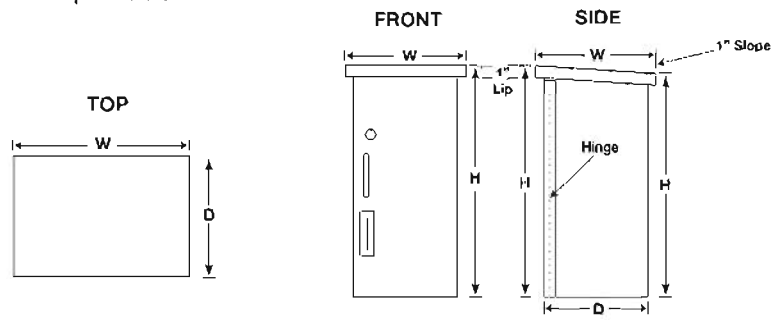
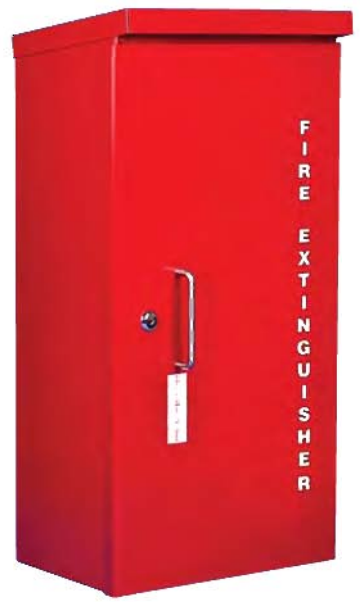

Mod. #	Trim Style	Interior Tub Size			Overall Outside Trim		Shipping Weight Lbs	Accom. Ext. Size Lbs
		W	H	D	W	H		
Heavy Duty Outdoor								
HDOC-10	-	11 1/2'	24"	7 3/4'	12'	25"	30	5 & 10
HDOC-20	-	14"	28"	9"	14"	28"	35	20
HDOC-30	-	14"	33"	9"	14"	33"	40	30

Outdoor Weatherproof Hose Storage

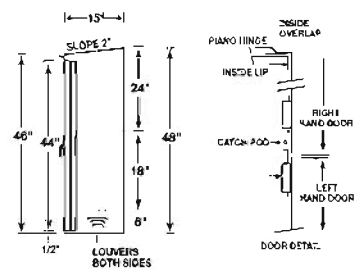

Hose Storage cabinet, constructed of 16 ga. satin coat galvanized metal with two coats red baked enamel. Stainless steel piano hinges with chrome plated door latches. Used to store fire hose and equipment for outdoor use in industrial applications.

- Wall Mounted (with rear lugs top & bottom)
- Concrete Base Mounted (with grouting lugs at bottom)

- Options:**
- Additional shelves upon request
 - Suitable brackets for Accessories
 - Support Mounted - legs packed separately (Steel fabricated legs available 24" or 36")
 - "Fire Hose" Decal

Mod. #	Description	Shipping Weight Lbs.
Heavy Duty Outdoor		
CM1101	Weatherproof Hose & Storage Cabinet - w/12" legs (standard)	250
CM1101-24	Weatherproof Hose & Storage Cabinet - w/24" legs	255
CM1101-36	Weatherproof Hose & Storage Cabinet - w/36" legs	265

Hose and Hydrant House

Hydrant House to protect hydrant and store hose and accessories. Constructed of 16 ga. satin coat steel with one coat grey primer and double coat baked red enamel. Stainless steel piano hinges and chrome plated latch.



Mod. #	Description	Shipping Weight Lbs
Hose and Hydrant House		
HYDRANT	Fire Hydrant and Hose Storage House 65 3/4" W x 72" H x 67 1/4" D	600

Parts and Accessories for Extinguisher Cabinets

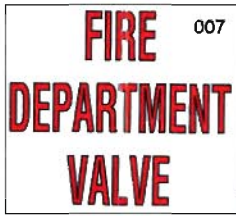

005



Model. #	Accessories Description
Decals	
003	Small Decal "Fire Extinguisher" Red or Black also available in die cut lettering (5lb cabinets)
004	Large Decal "Fire Extinguisher" Red or Black also available in die cut lettering (10 & 20 lb cabinets)
005	Decal "Fire Extinguisher" Red or Black horizontal
006	Decal "Fire Extinguisher" vertical arrow
007	Decal "Fire Department Valve" clear background
115	Diecut Vertical "Fire Extinguisher" Decal Red or Black Small & Large
Locks, and Anti Theft Accessories	
008	Safety Break Lock w/2 keys
ST1-6255	Mini Theft Stopper "Stop"

EMERGENCY Lighting Products and Photoluminescent Signs



LED Exit Signs
MAG-U2-EM

Product Features:

- Ni-cad battery on emergency (EM) units
- Red light with white housing



LED Exit Light
CMAG-EM

Product Features:

- 6-Volt pure lead, maintenance-free battery
- Red light with white housing



Lighting Unit
M-1-EM

Product Features:

- 6-Volt, pure lead, maintenance-free battery
- White housing

Photoluminescent Signs

OSHA 1910. 157(c)(1) The employer shall provide portable fire extinguishers and shall mount, locate and identify them so that they are readily accessible to employees without subjecting the employees to possible injury.



Model. #	Description
Emergency Battery EXIT Signs	
MAG-U2-EM	LED Exit Sign-Red Lettering and White Body
CMAG-EM	LED Exit Emergency Light-Red Lettering and White Body
M-1-EM	M-1 Emergency Lighting Unit-White
Jalite Photoluminescent EXIT Signs	
JAL-UL419	UL Photoluminescent EXIT Sign green lettering (Size: 7.875" x 17.75")
JAL-UL619	UL Photoluminescent EXIT Sign red lettering (Size: 7.875" x 17.75")
JAL-F007	Optional Aluminum Frame for UL419 and UL619
Jalite Photoluminescent Extinguisher Identification Signs	
JAL-US620FS	Photoluminescent ID Sign double sided "Fire Extinguisher" (Size: 4" x 18")
JAL-US620R	Photoluminescent ID Sign rigid "Fire extinguisher" (Size: 4" x 18")
JAL-6270P15	Photoluminescent ID Sign double sided (Size 6" x 6")
JAL-6422CR	Photoluminescent ID Sign rigid (Size: 6" x 6")
JAL-6422CV	Photoluminescent ID Sign vinyl adhesive (Size: 6" x 6")
JAL-6490DR	Photoluminescent ID Sign rigid "Fire extinguisher" (Size: 6" x 8")

ABC-Seamless Steel Cylinder Dry Chemical Fire Extinguishers

ABC Seamless Steel Cylinder Dry Chemical

A non-corrosive pull pin, completely rechargeable, anodized aluminum valve. Cylinder has high corrosion and impact resistant finish (red epoxy). Comes complete with wall bracket or vehicle bracket and a 6 year warranty. UL Listed.



Standard Bracket Included

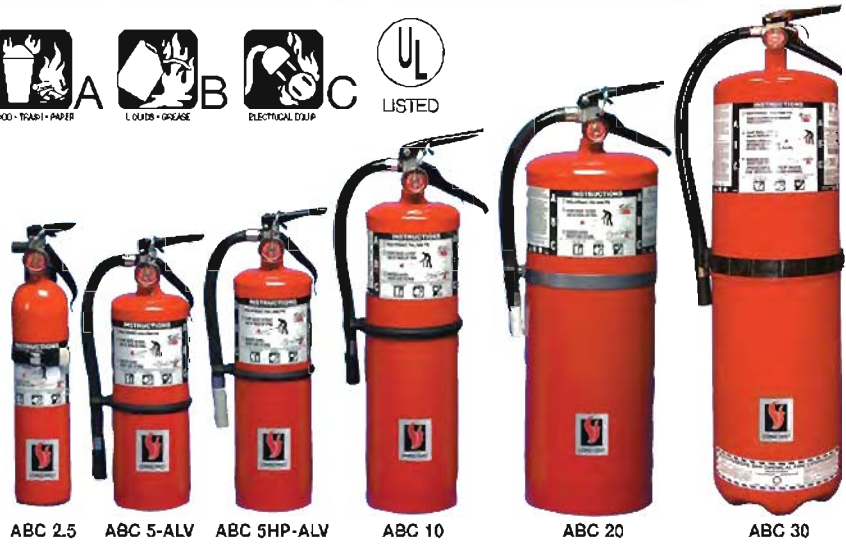

Model/Description	Nominal Capacity	Shipping Weight	Cylinder Diameter	Overall Height	Overall Width	PSI	Range	U/L Rating	Coast Guard Approved
		Lbs.	In.	In.	In.		Feet		
ABC Extinguishers									
ABC 2.5-W	2.5 lb	5	3 1/8	15 1/4	3 3/4	150	8-12	1A-10BC	-
ABC 2.5-V	2.5 lb	5	3 1/8	15 1/4	3 3/4	150	8-12	1A-10BC	Yes
ABC 5-ALV-W	5 lb	10 1/2	4 1/4	15 1/4	6 3/4	195	10-15	2A-10BC	-
ABC 5-ALV-V	5 lb	10 1/2	4 1/4	15 1/4	6 3/4	195	10-15	2A-10BC	Yes
ABC 5HP-ALV-W	5 lb	10 1/2	4 1/4	16 5/8	6 3/4	195	10-15	3A-40BC	-
ABC 5HP-ALV-V	5 lb	10 1/2	4 1/4	16 5/8	6 3/4	195	10-15	3A-40BC	Yes
ABC 10-W	10 lb	19 1/4	5 1/8	21 1/4	9 1/2	235	10-15	4A-80BC	Yes (w/024)
ABC 20-W	20 lb	35 1/4	7 1/8	24	9 1/2	235	12-18	10A-120BC	-
ABC 30-W	30 lb	50 1/3	7 1/8	30 3/4	9 1/2	195	10-15	10A-120BC	-

V = Vehicle Bracket W = Wall Bracket HP = High Performance

CO₂-Aluminum Cylinder Carbon Dioxide Fire Extinguishers

CO₂ Aluminum Cylinder Carbon Dioxide

Our CO₂ squeeze grip operation. Chrome plated valve is precision machined with stainless steel top and bottom handles. The finest CO₂ valve manufactured in the world today. Aluminum cylinder — complete with wall bracket and a 6 year warranty. UL Listed.

Standard Bracket Included



Model/Description	Nominal Capacity	Shipping Weight	Cylinder Diameter	Overall Height	Overall Width	PSI	Range	U/L Rating	Coast Guard Approved
		Lbs.	In.	In.	In.		Feet		
CO2 Extinguishers									
CO2-5	5 lb	13 1/4	5 3/4	17 1/4	10 1/4	-	6-12	5BC	-
CO2-10	10 lb	27	6 3/4	19 3/4	10 1/4	-	6-12	10BC	-
CO2-15	15 lb	37	6 3/4	26 3/4	10 1/4	-	6-12	10BC	-
CO2-20	20 lb	48 1/8	8	26 3/4	11 3/4	-	6-12	10BC	-

Fire Extinguisher Accessories

Standard Wall Brackets

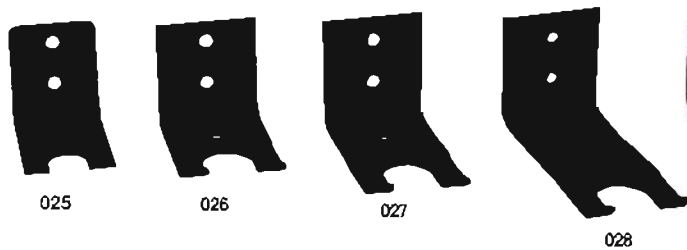

Vehicle Brackets

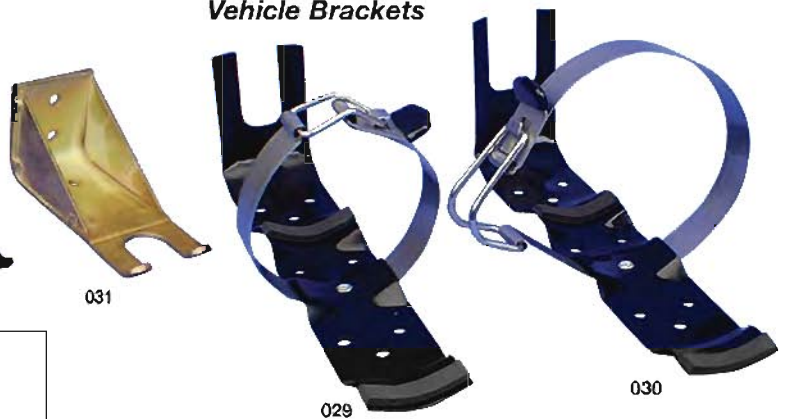

Heavy Duty Bracket

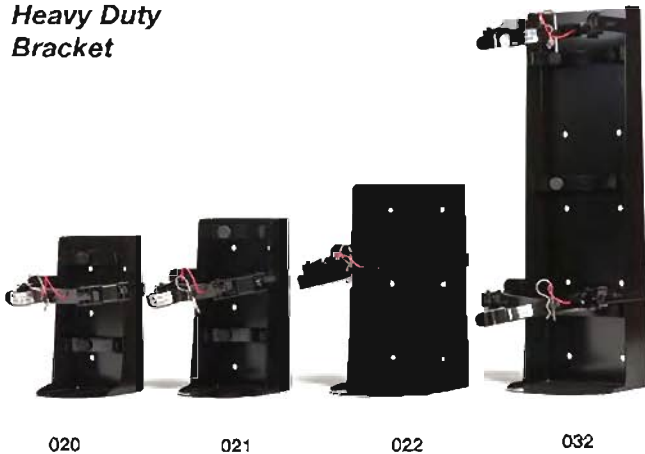

We offer a full line of Heavy Duty Vehicle Brackets for use with all ABC fire extinguishers. Proven welded steel construction with a stainless steel pull pin to keep bracket from vibrating open. Polyester powder coat finish. Individually boxed.

Medium Duty Double Strap Bracket

We also offer a Medium Duty Double Strap Vehicle Bracket for use with all 5lb and 10lb ABC fire extinguishers. Polyester powder coat finish. Heavy duty buckle closures. **Coast Guard approved with 10 lb. ABC extinguisher.**



023 Double Strap
024 Double Strap

Model. #	Accessories Description
Standard Brackets - Wall Brackets	
025	2.5lb. Standard Wall Bracket
026	5lb. ABC & HP Standard Wall Bracket
027	10lb. Standard Wall Bracket
028	20lb. Standard Wall Bracket
031	30lb. Standard Wall Bracket
Standard Brackets - Vehicle Brackets	
029	2.5lb. Standard Vehicle Bracket
030	5lb. Regular & HP Standard Vehicle Bracket
Heavy Duty Vehicle Brackets	
020	HDVB1 5lb. Heavy Duty Vehicle Bracket w/Pin & Safety Retainer
021	HDVB2 10lb. Heavy Duty Vehicle Bracket w/Pin & Safety Retainer
022	HDVB3 20lb. Heavy Duty Vehicle Bracket w/Pin & Safety Retainer
032	HDVB4 30lb. Heavy Duty Vehicle Bracket w/Pin & Safety Retainer
Medium Duty Double Strap Bracket	
023	5lb. ABC & HP Double Strap Vehicle Bracket
024	10lb. ABC Double Strap Vehicle Bracket
Wheeled Trolley Cart	
033	30lb. wheeled trolley cart <i>extinguisher not included</i>

Wheeled Trolley Cart for 30lb. ABC

We also offer a wheeled trolley for transporting 30lb. fire extinguishers. Stainless steel weld tube construction, wheels and a sturdy front foot for balance. (Extinguisher not included)



Distributed by
www.Ameraproducts.com
 Phone: (800) 608-6568
 Fax: (409) 840-5545
info@ameraproducts.com

Portable Fire Extinguisher Stand

the Centurion™

fits ALL 10 lb and 20 lb ABC
 Fire Extinguishers



Plastic Cabinet (PC-Sold separately on page 9) cabinet with body and frame injection molded in red virgin high-impact crystal polystyrene of .110 wall thickness with ultra-violet inhibitors, virgin acrylic Plaskolite™ panel of .080 thickness. Chromium plated brass safety lock and key with weather-proof protective lock cover and polypropylene plastic injected molded hammer.

- Red bodies shipped with red hammer and lock covers
- the Centurion fits ALL 10 lb and 20 lb ABC fire extinguishers, fully assembled portable fire extinguisher stand (extinguisher not included).
- Lightweight molded polyethylene for maximum weatherability
- Equipped with required safety decals
- Environmentally safe sand filled base (10 lb has 20 lbs of sand, 20 lb has 25 lb sand base)
- Top and bottom 16 ga steel Galva Coat brackets are powder coated
- Faultless casters for easy mobility

Options:

- Mini Theft Stopper (item ST1-6255)
- Large Vertical Decal and Arrow Decal (item 004 and 006)



NOTE: Must be placed in a visible area and easy to access.

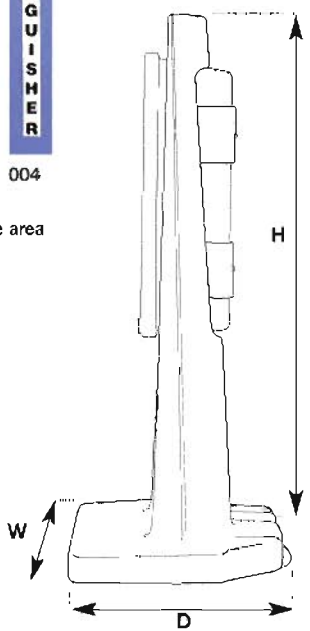

(Extinguisher not included)

Patent No: US D581,183S

Model #	Ext. Capacity	W	Overall Dimensions		Shipping Wt Pallet of 4*	Shipping Wt Single Unit
			H	D		
CENTURION-10	10#	22"	45 3/4"	17 1/2" w/casters	208 lbs*	78 lbs*
CENTURION-20	20#	27 1/2"	56"	21" w/casters	280 lbs*	96 lbs*
Accessories						
ANCHOR-10	10# Base Anchoring Strap Brackets (per 2) stainless steel				-	-
ANCHOR-20	20# Base Anchoring Strap Brackets (per 2) stainless steel				-	-
SS Bracket-10	10# Top and Bottom Brackets stainless steel				-	-
SS Bracket-20	20# Top and Bottom Brackets stainless steel				-	-

TRAFFIC Safety Products



Safety Vests

AV100
AV100-R reflecterized
Reflectorized Safety Vest

Brilliant fluorescent orange color can be seen for long distances even in bad weather and semi-dark conditions. Semi-flexible, knitted vinyl material is exceptionally rugged. The reflectorized model has yellow reflective stripes on the front and back of the vest to make workers visible for great distances and at night.



Safety Cones

1005 Standard 28"
1002 Standard 18"
REF-Collars

Reflective Collars

- Anti-fade, fluorescent orange color
- Broad base for stability
- Heat resistant to 160°
- Meet NCHRP350 requirements
- Meet MUTCD and FHWA requirements
- Elongation: 200%
- Tear strength: 250 psi



Safety Triangles

1092

Pyraflare Emergency Warning Triangle

This durable safety triangle is held in place by a positive base lock that is activated by rotating it 90° to the base, aligning it perfectly so it will not tip over or be affected by truck turbulence. Comes with convenient carrying case. Exceeds FMVSS 125 specifications and meets all D.O.T. standards.

GUARD Posts

Sentry Guard Posts

SGP

- 48" high, 14" tapered base made of durable, weather-resistant polyethylene
- Quickly and easily works with plastic chain for versatile traffic configuration
- Integrated snap-on cap for internal storage and ballast options



SAFETY STORAGE Products

Lead-free technology featuring environmentally friendly hot dipped 24-gauge steel, baked on powder coat finish

Patented comfort grip trigger release

Fixed handle

Spring closing lid with neoprene gasket vents at 5 psi internal pressure

HDPE funnel fits unleaded fuel tanks, also available separately

Non-sparking brass flame arrestor and pour spout

Deep drawn construction means no top or side seam, the ONLY deep drawn unleaded can made

Double interlock no-weld bottom seam



UI-50-S (5 gal)
12 1/2" x 13 1/2"

UI-20-FS (2 gal)
11 1/4" x 9 1/2"

Type I Safety Can

UI-10-FS w/funnel, 1 gal

UI-20-FS w/funnel, 2 gal

UI-50-FS w/funnel, 5 gal

UI-00-FS funnel replacement

Product Features:

- Meet OSHA and NFPA Code 30 requirements
- UL and ULC listed and FM approved for safe handling and storage of flammable liquids
- Constructed of 24-gauge hot dipped galvanized steel
- Available in blue for kerosene (B) and yellow for diesel (Y)
- Environmentally friendly Lead Free Technology

UI-20-FS
Patented

100% LEAK TESTED

Compliance: OSHA & NFPA Code 30 requirements, FM, UL & ULC approved

Distributed by
www.Ameraproducts.com

Phone: (800) 608-6568

Fax: (409) 840-5545

info@ameraproducts.com

SAFETY STORAGE Products

Distributed by
www.Ameraproducts.com
 Phone: (800) 608-6568
 Fax: (409) 840-5545
 Info@ameraproducts.com



U2-51-S (5 gal)
 12 1/2" x 13 1/2"

U2-26-S (2 gal)
 11 1/4" x 9 1/2"



1215 (5 gal)
 12 1/2" x 15 3/4"

1535 (3 gal)
 12 1/2" x 13"

1541 (5 gal)
 12 1/2" x 17"

Type II Safety Cans

U2-26-S 7/8" spout, 2 gal **U2-26-SX5** 5/8" spout, 2 gal
U2-51-S 7/8" spout, 5 gal **U2-51-SX5** 5/8" spout, 5 gal

Product Features:

- Two openings, one with a pressure-relief spring closing lid for filling, one with an actuated pour valve with a flexible metal spout for safer controlled dispensing
- Filler spout and flame arrestors in both openings are non-sparking brass for flashback protection
- Also available in blue for kerosene (B) and yellow for diesel (Y), add color code to end of model number
- Compliance: OSHA and NFPA Code 30 requirements
- UL and ULC listed and FM approved for safe handling and storage of flammable liquids

DOT Transport Safety Cans

1215 5 ga

Product Features:

- Has double-walled brass flame arrestors in filler opening and pour spout
- Help reduce the danger of explosions while dispensing flammable liquids through a flexible metal spout
- Compliance: OSHA 29 CFR 1910.106, 1925.152 and NFPA Code 30
- Heavy duty roll bars protect both spouts and a thumb screw mechanism assures that the filler opening stays closed while being transported

Type I Poly Lab Cans

1535 white poly, 3 gal

1541 white poly, 5 gal

Product Features:

- Impervious to many liquid chemicals, acids, caustics, solvents and corrosives
- Help reduce the danger of explosions
- High density polyethylene cans are dent and puncture resistant and feature corrosive resistant stainless steel fittings and brass grounding connectors
- HDPE with stainless steel fixtures



1206G (5 qt)
 15 1/4" x 37 3/4"

1208BLK (4 gal)
 17 1/4" x 43 1/4"

Cigarette Receptical

1206 5 quart (gray or black)

1208 4 gallon (gray or black)

Product Features:

- Ideal for "smoking areas" inside or out
- Made of high density polyethylene with UV inhibitors
- Galvanized steel collection bucket inside
- Top of container removes easily to access and empty the bucket and keeps water out
- Eliminates waste smell
- All are FM approved

Container top removes easily to empty internal galvanized steel bucket



1301 (1 gal)
 6" x 8" x 13"

1401 (1 gal)
 6" x 8" x 13"

Lab Cans

(special order only)

1301 stainless steel, 1 gal

1401 red metal, 1 gal

Product Features:

- Available in coated metal and stainless steel for safe storage and handling of most chemical compounds
- All are FM approved
- Compliance: OSHA 29 CFR 1910.106, 1925.152 and NFPA Code 30

SAFETY STORAGE Products

Distributed by
www.Ameraproducts.com
 Phone: (800) 608-6568
 Fax: (409) 840-5545
 info@ameraproducts.com



937-FL (14 gal)
 22" x 18" x 21"



1423 (2 1/2 gal)
 11 1/4" x 12"

1325 (5 gal)
 11 1/4" x 18"



P-701 (1 qt)
 6 1/4" x 8"

Poly Oily Waste Cans

- 933-FL 6 gal 933-FLY 6 gal
- 935-FL 10 gal 935-FLY 10 gal
- 937-FL 14 gal 937-FLY 14 gal

Product Features:

- Fire safe temporary storage of solvent, waste rags, shavings and other materials subject to spontaneous combustion
- Polyethylene construction for excellent chemical resistance
- Self-closing lid w/foot lever
- All are FM approved
- Compliance: OSHA 29 CFR 1910.108 and OSHA 29 CFR 1910.106
- Comes in high visibility yellow (FLY) and red (FL)

Disposal Cans

(special order only)

- 1323 type 316 stainless steel 2 1/2 gal
- 1325 type 316 stainless steel 5 gal
- 1423 galvanized flame arrestor 2 1/2 gal
- 1425 galvanized flame arrestor 5 gal

Product Features:

- Galvanized steel is ideal for disposal of flammable petroleum based wastes
- Type 316 stainless steel recommended with most alcohols, ethers, aromatics, hydrocarbons and chlorinated hydrocarbon wastes
- All are FM approved and feature wide 4" spout cap that locks open to 80 degree angle
- All have flame arrestor, a free swinging handle and auto vent cap

Metal Plunger Cans

- P-701 1 quart
- P-702 2 quart
- P-704 4 quart

Product Features:

- Red galvanized steel construction, ideal for cleaning with flammable or volatile fluids
- When the dasher plate is pushed down, the safety can dispenses a small amount of liquid to easily moisten sponges or rags without messy or dangerous spills
- All are FM approved
- Compliance: OSHA 29 CFR 1910.106, 1925.152 and NFPA Code 30
- All have brass flame arrestor dasher screens and pump assemblies

SAFETY STORAGE Products

Safety Cabinets: Flammable Liquid, Tower, Paint and Ink, Acid and Corrosive, and Poly Acid and Corrosive

Product Features:

- Cabinets available from 4 gal to 120 gal
- Cabinets are available in 2 door styles: manual 1 and 2 doors and self-closing, self-latching w/hydraulically operated doors w/fusible links
- Meet OSHA and NFPA Code 30 Specifications
- High visibility safety yellow HDPE
- Self-closing models meet UFC 79
- Cabinets are available in 4 colors based on the type of cabinet

Reinforced double wall construction w/1 1/2" air space on sides, top, bottom and doors

Lead-free high gloss baked-on powder coat finish

2" vent w/fire baffle and cap on both sides

Internal and external welded construction

Tri-lingual warning labels

3 point key lock w/button latch, all cabinets have self latching doors

Continuous piano hinge

Ground connector

Adjustable galvanized steel shelves holds 350 lbs. Includes 4 3/4" centers for shelf brackets

2" raised leakproof sill

4 adjustable galvanized leveling legs

Available 4 colors

(based on the type of cabinet you need)



Flammable Storage Cabinet



Paint & Ink Storage Cabinet



Acid & Corrosive Storage Cabinet



Poly Acid & Corrosive Storage Cabinet

Flammable Liquid



Bench Top

- 1903 self close
- 1904 manual close
- 1902 add. shelves

Product Features:

- 4 gal capacity
- 1 Shelf: Depth 14 3/4"
- Maximum weight 80 lbs.
- OSHA/NFPA Code 30

Dims:	W	D	H
Outer	17 1/2"	18"	22 1/2"
Inner	14 1/2"	15"	19 1/2"



Space Saver

- 1924 self close
- 1925 manual close
- 1919 add. shelves

Product Features:

- 12 gal capacity
- 1 Shelf: Depth 14 3/4"
- Maximum weight 135 lbs.
- OSHA/NFPA Code 30

Dims:	W	D	H
Outer	23"	18"	35"
Inner	20"	15"	32"

Also available in 16 gal, and 30 gal. For full details visit our web site



Standard 45

- 4510 self close
- 1947 manual close
- 1915 add. shelves

Product Features:

- 45 gal capacity
- 2 Shelves: Depth 14 3/4"
- Maximum weight 353 lbs.
- OSHA/NFPA Code 30 and FM tested and approved

Dim:	W	D	H
Outer	43"	18"	65"
Inner	40"	15"	62"

All steel cabinets meet NFPA Code 30 and OSHA specifications.

Self-closing models meet Uniform Fire Code and NFPA Code One requirements.



Cabinets include 4" adjustable legs

- Cabinets can be placed over floor or wall ventilation
- Provide easy cleaning under cabinets
- Protection in areas where floor moisture is a concern
- Cabinets can be moved with a fork lift or pallet jack
- High visibility safety yellow HDPE



Space Saver w/Legs

- 1924LEGS self close
- 1925LEGS manual close
- 1919 add. shelves

Product Features:

- 12 gal capacity
- 1 Shelf: Depth 14 3/4"
- Maximum weight 143 lbs.
- OSHA/NFPA Code 30

Dim:	W	D	H
Outer	23"	18"	39"
Inner	20"	15"	32"



Space Saver w/Legs

- 1905LEGS self close
- 1906LEGS manual close
- 1919 add. shelves

Product Features:

- 16 gal capacity
- 1 Shelf: Depth 14 3/4"
- Maximum weight 160 lbs.
- OSHA/NFPA Code 30

Dim:	W	D	H
Outer	23"	18"	48"
Inner	20"	15"	41"



Tower 45

- 4510LEGS self close
- 1947LEGS manual close
- 1915 add. shelves

Product Features:

- 45 gal capacity
- Shelf Depth 14 3/4" (2)
- Maximum weight 353 lbs.
- OSHA/NFPA Code 30 and FM tested and approved

Dim:	W	D	H
Outer	43"	18"	69"
Inner	40"	15"	62"

Also available in 30 gal., 60 gal. and 90 gal. For full details visit our web site

Paint and Ink

Special Features:

- Capacity is based upon the number of 1-gallon paint cans
- Aerosol cabinets include wall mount brackets and holds up to 252-12 oz. aerosol cans



Standard 40

- PI-3010 self close
- PI-32 manual close
- 1915 add. shelves

Product Features:

- 40 gal capacity
- Shelf Depth 14 3/4" (3)
- Maximum weight 281 lbs.
- OSHA/NFPA Code 30 and FM tested and approved

Dim:	W	D	H
Outer	43"	18"	44"
Inner	40"	15"	41"

Also available in 60 gal. For full details visit our web site

SAFETY STORAGE Products

Acid and Corrosive

Standard Features in Addition to the Benefits on Page 18:

- Special corrosive resistant powder coat finish on all internal and external surfaces, including shelves
- Includes poly shelf and bottom trays to help contain small spills and provide extra corrosive protection
- Steel cabinets are not recommended for the storage of aggressive acids such as nitric, sulfuric and hydrochloric
- Also available in 100% polyethylene construction for aggressive acids



Bench Top

CRA-1903 self close
CRA-1904 manual close
CRA-1902 add. shelves

Product Features:

- 4 gal capacity
- Shelf Depth 14 3/4" (1)
- Maximum weight 80 lbs.
- OSHA/NFPA Code 30

Dim:	W	D	H
Outer	17 1/2"	18"	22 1/2"
Inner	14 1/2"	15"	19 1/2"



Space Saver

CRA-2310 self close
CRA-23 manual close
CRA-1909 add. shelves

Product Features:

- 24 gal capacity
- Shelf Depth 14 3/4" (3)
- Maximum weight 270 lbs.
- OSHA/NFPA Code 30

Dim:	W	D	H
Outer	23"	18"	65"
Inner	20"	15"	62"



Standard 30

CRA-3210 self close
CRA-32 manual close
CRA-1914 add. shelves

Product Features:

- 30 gal capacity
- Shelf Depth 14 3/4" (1)
- Maximum weight 257 lbs.
- OSHA/NFPA Code 30 and FM tested and approved

Dim:	W	D	H
Outer	43"	18"	44"
Inner	40"	15"	41"

Also available in 45 gal.
 For full details visit our web site

Poly Acid and Corrosive

100% polyethylene construction for aggressive acids

- Sealed internal and top spill sumps, adjustable shelves, storage in door for small bottles, and specific warning labels
- Includes 2-2" poly vents w/caps, poly leveling legs,
- Lockable doors for secure storage of dangerous acids



Under Counter

CRA-P22 manual close, blue (white available)
CRA-PS22 add. shelves

Product Features:

- 22 gal capacity
- Shelf Depth 12" (2)
- Maximum weight 95 lbs.
- OSHA/NFPA Code 30 and FM tested and approved

Dim:	W	D	H
Outer	35"	22"	36"
Inner	32"	19"	33"



Standard

CRA-P44 manual close, blue (white available)
CRA-PS22 add. shelves

Product Features:

- 44 gal capacity
- Shelf Depth 12" (4)
- Maximum weight 130 lbs.
- OSHA/NFPA Code 30 and FM tested and approved

Dim:	W	D	H
Outer	35"	22"	65"
Inner	32"	19"	58"

Drum/Haz-Mat

Special Features:

- Drum Cabinet includes drum support guides in bottom and 1 shelf
- Haz-Mat includes roller conveyor in bottom, 1 shelf and Haz-Mat label



One Drum Vertical

2610 self close
1926 manual close
HAZ2610 self close
HAZ1926 manual close
1921 add. shelves

Product Features:

- 55 gal capacity
- Shelf Depth 14 3/4" (1)
- Maximum weight 350 lbs.
- OSHA/NFPA Code 30 and FM tested and approved

Dim:	W	D	H
Outer	31 1/4"	31 1/4"	65"
Inner	28 1/4"	28 1/4"	62"



Two Drum Vertical

5510 self close
1955 manual close
HAZ5510 self close
HAZ1955 manual close
1922 add. shelves

Product Features:

- 110 gal capacity
- Shelf Depth 14 3/4" (4)
- Maximum weight 575 lbs.
- OSHA/NFPA Code 30 and FM tested and approved

Dim:	W	D	H
Outer	58"	31 1/2"	65"
Inner	55"	28 1/2"	62"

WARRANTY

Strike First Corporation of America

Extinguisher Warranty

Strike First Corporation warrants its fire extinguishers to be free from defects in material and workmanship for a period of six years from the date of purchase. During the warranty period, any such defects will be repaired or the defective extinguisher replaced (**IF THE ORIGINAL SEAL IS INTACT AND/OR IF ONLY FACTORY**

REPLACEMENT PARTS HAVE BEEN USED TO SERVICE THE EXTINGUISHER). This warranty does not cover defects resulting from modifications, alteration, misuse, exposure to corrosive conditions or improper installation or maintenance. **ALL IMPLIED WARRANTIES, INCLUDING BUT NOT LIMITED TO WARRANTIES OF FITNESS FOR PURPOSE AND MERCHANTABILITY ARE LIMITED TO THE TIME PERIOD AS STATED ABOVE. IN NO EVENT SHALL STRIKE FIRST CORPORATION BE LIABLE FOR INCIDENTAL OR CONSEQUENTIAL DAMAGES.** Strike First Corporation neither assumes nor authorizes any representative or other person to assume for it any obligation or liability other than as expressly set forth herein. This warranty gives you specific legal rights and you may also have other rights which vary from state to state.

Fire Extinguisher Cabinet Warranty

The Strike First Corporation of America (the "Seller") provides the following warranty of its cabinets: All cabinets sold hereunder are warranted to be free from defects in material and workmanship for a period of one (1) year. The purchaser agrees that he will inspect the goods upon delivery. Every claim for defective material or workmanship or negligence or from any other cause shall be deemed waived by the purchaser unless made to the Seller in writing within ninety (90) days of the date of shipment from purchaser to purchasers' customer provided that all such claims for goods restocked for resale must be submitted in writing to the Seller within one (1) year from receipt by purchaser of the goods to which such claims relate. Defective goods for which a valid claim has been made shall be returned to the Seller and defective goods so returned will be replaced or repaired without charge, but the Seller shall not be liable for any other loss, damage or expense, **INCLUDING BUT NOT LIMITED TO CONSEQUENTIAL DAMAGES**, directly or indirectly arising from the condition or use of the goods or from any other cause, the exclusive remedy against the Seller being to require the replacement or repair of defective goods. **THIS WARRANTY IS THE SOLE AND EXCLUSIVE WARRANTY PROVIDED TO THE PURCHASER. THERE ARE NO WARRANTIES WHICH EXTEND BEYOND THE DESCRIPTION OF THE FACE HEREOF. THE SELLER HEREBY DISCLAIMS ALL OTHER WARRANTIES, EXPRESS AND IMPLIED, INCLUDING BUT NOT LIMITED TO THE IMPLIED WARRANTIES OF MERCHANTABILITY AND FITNESS FOR A PARTICULAR PURPOSE.**

ADA COMPLIANCE

ADA ACCESSIBLE GUIDELINE 4.4

Cabinets and Fire Extinguishers projecting from walls with their leading edges between 27 inches and 80 inches above the finished floor shall protrude no more than 4 inches into walks, halls, corridors, passageways, or aisle. Objects mounted with their leading edges at or below 27 inches above the finished floor may protrude any amount. Freestanding objects mounted on posts or pylons may overhang 12 inches maximum from 27 inches to 80 inches above the ground or finished floor. Protruding objects shall not reduce the clear width of an accessible route or maneuvering space.

To comply with ADA Guidelines, Strike First Extinguishers and Cabinets offer handles, brackets and return trims according to instructions provided by installer. For ADA compliance follow the specification ordering process dimensions in our catalog. Proper installation in accordance with the ADA Guidelines is the sole responsibility of the installer.



ADA handle option

TABLE of CONTENTS

Warranty	2
ADA Compliance	2
Specification Guidelines	3
Important Information	3
Cabinet Measuring Guidelines	4
Installation Options	4
Fire-Rated Installation Guidelines	4
Extinguisher Cabinets & Extinguishers	
Elite Architectural Series Cabinets	5
Sonoma Extinguisher Cabinets	6
Titan Series Aluminum Cabinets	7
VC and VEC Series Valve Cabinets	8
BC-Bubble Canopy Cabinets	8
Classic Series Cabinets	9
Plastic Extinguisher Cabinets	9
Heavy Duty Outdoor Cabinets	10
Outdoor Weatherproof Hose Cabinets	10
Fire Hose and Hydrant House	10
Cabinet Parts & Accessories	11
Mini Theft Stopper	11
Fire Extinguishers	12
Fire Extinguisher Accessories	13
The Centurion Portable Extinguisher Stand	14
Safety Products	
Emergency Lighting	11
Traffic Safety	15
Sentry Guard Post	15
Safety Storage Products	
Flammable Type I & II Safety Cans	15-16
Specialty Cans & Cigarette Cans	16-17
Flammable Liquid Cabinets	17-19
Flammable Tower Cabinets	17-19
Paint & Ink Cabinets	18
Acid Corrosive Cabinets	19
Drum HAZ-MAT Cabinets	19
Spill Containment Products	
Modular Platform System	20
Pallet System	20
Drum Stacking System	20
Outdoor Drum Storage	21
Accessories	21
Over Packs & Salvage Drums	21
Safety Protection Products	
Guards & Protection	22-23
Safety Ramps	23
Letter from the President	24

Distributed by

www.Ameraproducts.com

Phone: (800) 608-6568

Fax: (409) 840-5545

info@ameraproducts.com

SPILL CONTAINMENT Products

Modular Spill Platform System

Product Features:

- Can be arranged in many suitable configurations
- Low profile for easier loading and unloading
- 30 gallon spill capacity per 2 drum side
- Blow molded high density polyethylene construction for superior strength and excellent chemical resistance
- Each 2 drum unit includes one 2' U-channel connector to join units
- Removable poly grating

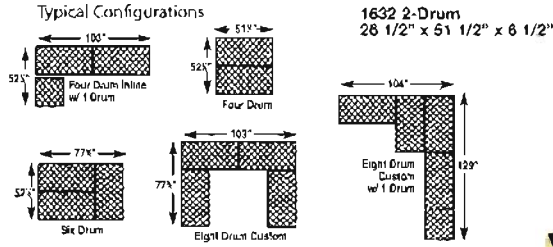

1632 Battery Storage



This marker indicates compliance with EPA spill prevention, control and countermeasures regulations.

1634 4-Drum
52 1/2" x 51 1/2" x 6 1/2"



Model #	Description	Dimensions	Spill Capacity	Load Capacity
Modular Spill Platform System				
1632	2-Drum Modular Platform	26 1/4" x 51 1/2" x 6 1/2"	30 gal	5,000 lbs
1633	1-Drum Modular Platform	26" x 26" x 6 1/2"	12 gal	2,000 lbs.
1634	4-Drum Modular Platform	52 1/2" x 51 1/2" x 6 1/2"	60 gal (30 per)	10,000 lbs.
Platform Containment Platforms (Special Order Only)				
1647	4 Drum In-line Spill Platform	106" x 30 1/4" x 6 3/4"	30 gal	5,000 lbs
1686	6 Drum Pallet Unit Profile	77" x 51 1/2" x 6 1/2"	12 gal	2,000 lbs.
1688	8 Drum Pallet Unit Profile	104" x 51 1/2" x 6 1/2"	60 gal (30 per)	10,000 lbs.
Horizontal Drum Stacking System (Special Order Only)				
1605	Cradle*	29" x 26.5" x 22.5"	-	2,000 lbs
1606	Single Stacker	27" x 26.5" x 29"	-	1,000 lbs.
1607	Double Stacker	48" x 26.5" x 13"	-	2,000 lbs.
1608	Shelf	19" x 23" x 19"	-	1,000 lbs.
1642	Grating	51 1/4" x 25 1/4"	-	-
1642-S	Grating square	25 1/4" x 25 1/4"	-	-



1647 4-Drum In-line
106" x 30 1/4" x 6 3/4"

Spill Containment Platforms (Special Order)

Product Features:

- Low profile for easy access
- Polyethylene construction for excellent chemical resistance
- Grating with 1 3/4" square opening that removes easily for cleaning
- Compatible with Poly Ramp 1689
- Meet EPA requirement for secondary spill containment of hazardous materials (40 CFR 264.175)

Drum Stacking System (Special Order)

- 1606 single stacker
- 1607 double stacker
- 1608 shelf
- 1642 grating
- 1642-S grating (square)

Product Features:

- Polyethylene construction for excellent chemical resistance
- Units interlock into spill pallet grating for stable drum storage
- Shelf attaches easily for filling more than one container at a time
- Stackers let you double up on storage
- Double stackers are forkliftable

1689 Poly Ramp
45 1/2" x 32" x 8"
see information on page 14

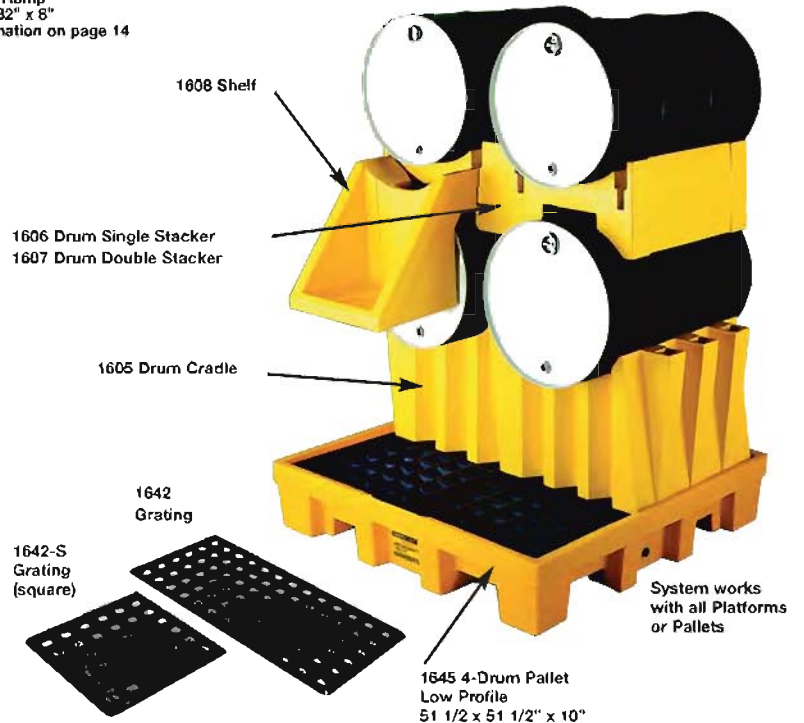

*Fits all Platforms and Pallets

System works with all Platforms or Pallets

SPILL CONTAINMENT Products



1649 4-Drum Storage Building w/optional Poly Ramp (1689)
 66 gal. spill capacity
 57 1/2" x 57 1/2" x 72"
 Door opening: 49" x 50 5/8"

Outdoor Containment

4 Drum Storage Building

1649 4 drum

- Securely store up to 4 drums, up to 8,000 lbs. load capacity
- Four-way forklift pockets, vented door louvers
- Removable grating and top hooks for moving
- New door size fits 48" x 48" pallet
- Compliance EPA CFR 264.175

Rotary Top Containment

1646RTC 4 drum

- Securely store up to 4 drums, up to 6,000 lbs. load capacity, 66 gal sump, rotary style pallet
- height of cover allows storage with drum pumps in place
- 100% polyethylene construction resists corrosion and weathering
- Dual entry with rotary top
- Compliance EPA 40 CFR 264.175



1646RTC 4-Drum Rotary Top Containment Unit
 66 gal. spill cap.
 59 1/2" x 73 1/2" x 68"

Model	Description	Dimensions
Outdoor Drum Storage System (Special Order Only)		
1646RTC	4-Drum Rotary Top Unit	59 1/2" x 73 1/2" x 68"
1649	4-Drum Poly Storage Building	57 1/2" x 57 1/2" x 72"
1689	Poly Ramp for 1646RTC and 1649	45 1/2" x 32" x 8"
Drum Accessories		
1613	Drum Bogie	35 3/4" x 42"
1670	Drip Pan	Outside: 10 1/2" x 10 1/2" x 3"
1660	Drum Funnel	18" x 7"
1664	Drum Funnel Cover	18 1/2" x 5"
Overpack & Salvage Drum		
1661	30 gal Drum Overpack w/screw lid	31" x 26 1/16" x 33 3/4"
1665	55 gal Salvage Drum w/metal band/bolt	31" x 26" x 38 7/8"

DRUM Accessories



Drip Pans
1670
Product Features:

- 10 1/2" x 10 1/2" x 3"
- High visibility safety yellow HDPE
- Filled with Polypropylene

Drum Bogie
1613
Product Features:

- Mobile dispensing unit protects against spills and leaks for 30, 55, 95 gallon drums
- Durable polyethylene construction, poly push-pull handle
- 5 - 3" swivel casters for maximum stability, load capacity and maneuverability
- 1,250 lbs. load capacity, spill capacity is 12 gal



Drum Funnel & Cover
1660 funnel
1664 cover

- Compliance: EPA 40 CFR 265.173

Overpack & Salvage Drum



1661 30 gal Overpack



1665 65 gal Salvage Drum

30 gal Overpack & 65 gal Salvage Drum

1661 screw-on lid, 45 lbs.
 31" x 26 7/16" x 31 1/4"

1665 metal band w/bolt lid
 31" x 26" x 38 7/8"

- Product Features:**
- HDPE construction, incinerates completely, operating temperature range -30°F to 130°F, UL 94HB flammable rating
 - UV protection package, constructed of tough, chemical and weather resistant high density polyethylene, use with large non-damaging containers, cans and drums of non-leaking hazardous materials, if leaking, requires sufficient sorbents, STACK TESTED: 3 high maximum weight cap. 24 hrs, DROP TESTED: maximum weight @ 0°F (48 hrs) - 6' drop
 - Approved for use with Packing Groups I, II, & III
 - United Nations (UN) certified to HM-181
 - Compliance: DOT 49 CFR 173.25
 - Meets FDA 21 CFR 177.1520 Food Grade Quality

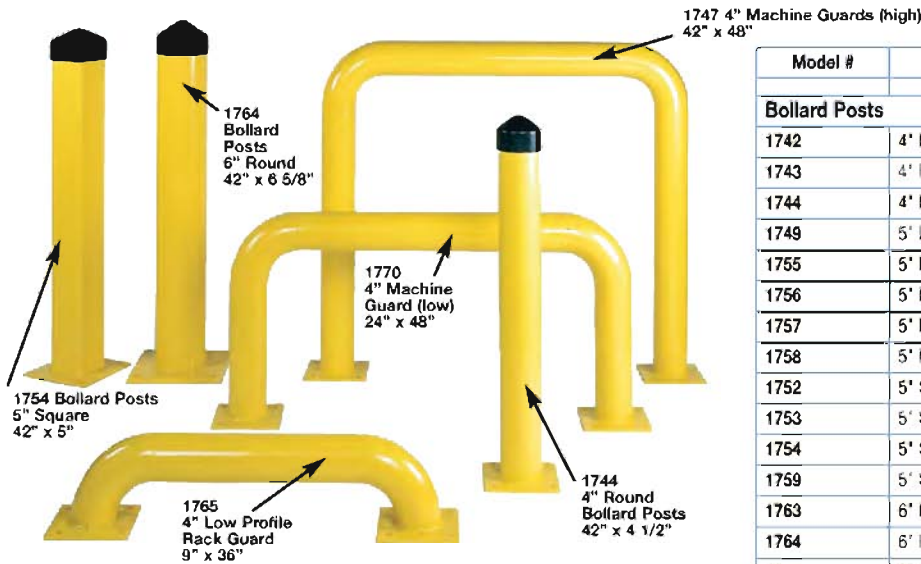

Bollard Posts

Product Features:

- High visibility, prevents damage
- Durable baked on powder coat in safety yellow
- Made with 1/4" thick steel mounted on 3/8" steel pre-drilled plates
- Black HDPE post removable caps included
- Posts can be filled with concrete for extra protection
- Posts come either square or round
- Anchor hardware not included

Machine Guards

Product Features:

- Provides superior protection for your facilities and equipment
- Create barriers between traffic areas and machinery
- Durable baked on powder coat in safety yellow
- High visibility
- Made with 1/4" thick steel mounted on 3/8" steel pre-drilled plates
- Anchor hardware not included

Model #	Description	Dimensions	Plate Size
Bollard Posts			
1742	4' Round	24" H x 4.5"	8" x 8" x 3/8"
1743	4' Round	36" H x 4.5"	8" x 8" x 3/8"
1744	4' Round	36" H x 4.5"	8" x 8" x 3/8"
1749	5' Round CAP	5" dia	-
1755	5' Round	24" H x 5.6"	10" x 10" x 3/8"
1756	5' Round	36" H x 5.6"	10" x 10" x 3/8"
1757	5' Round	42" H x 5.6"	10" x 10" x 3/8"
1758	5' Round CAP	5.85" dia	-
1752	5' Square	24" H x 5"	10" x 10" x 3/8"
1753	5' Square	36" H x 5"	10" x 10" x 3/8"
1754	5' Square	42" H x 5"	10" x 10" x 3/8"
1759	5' Square CAP	5.25 Sq	-
1763	6' Round	36" H x 6.625"	10" x 12" x 3/8"
1764	6' Round	42" H x 6.625"	10" x 12" x 3/8"
1769	6' Round CAP	7" dia	-
Machine and Rack Guards			
1765	4' Rack Guard <i>low profile</i>	9" H x 36"	8" x 8" x 3/8"
1745	4' Rack Guard <i>low profile</i>	9" H x 48"	8" x 8" x 3/8"
1772	4' Rack Guard	16" H x 36"	8" x 8" x 3/8"
1773	4' Rack Guard	16" H x 48"	8" x 8" x 3/8"
1746	4' Machine Guard <i>low</i>	24" H x 36"	8" x 8" x 3/8"
1770	4' Machine Guard <i>low</i>	24" H x 48"	8" x 8" x 3/8"
1774	4' Machine Guard	36" H x 36"	8" x 8" x 3/8"
1775	4' Machine Guard	36" H x 48"	8" x 8" x 3/8"
1771	4' Machine Guard <i>high</i>	42" H x 36"	8" x 8" x 3/8"
1747	4' Machine Guard <i>high</i>	42" H x 48"	8" x 8" x 3/8"

1730Y
 6" Bumper Post Sleeve
 7 5/8" x 57" 8lbs.



Bumper Post Sleeves

- 1732* 4" Post, 5 3/4" x 56", 5 lbs.
- 1730* 6" Post, 7 5/8" x 56", 8 lbs.
- 1730-72 6" Post, 5 3/4" x 72", 11 lbs. (yellow only)
- 1738* 8" Post, 10" x 57", 9 lbs.
- 1738-72 8" Post, 10" x 72", 15 lbs. (yellow only)

Product Features:

- Makes old bollard posts look like new, resists fading, rusting, cracking, eliminates maintenance
- High-visibility yellow HDPE construction w/UV inhibitors
- Sleeves are 56" or 72" long to trim for exact fit
- Available in 4", 6", and 8" N.P.T. pipe size
- Indicate color codes: Yellow (Y), White (W), Red (R), Blue (BL) Green (GN), Orange (OR), Lime (LM) Brown (BR), Black (BLK)

*Please specify color when ordering



Poly Guide-Post Delineators

1734* G-Post, 6lbs.

Product Features:

- Lightweight, portable, yieldable plastic post used to warn, guide and delineate
- Weather resistant high density polyethylene w/UV inhibitors, 42" high x 5 3/4" width
- Two 3" wide reflective silver bands for night visibility, MUTCD compliant
- Mounted on a 10" square HDPE plate w/anchor slots
- Anchor hardware not included
- Indicate color codes: Yellow (Y), Orange (OR), Lime (LM)

*Please specify color when ordering

SAFETY PROTECTION Products

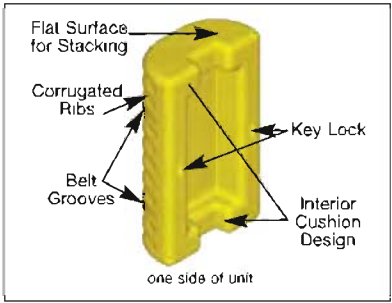

Column Protectors

- 1706* Square Profile, 24" x 24" x 42" 6" column
- 1708* Square Profile, 24" x 24" x 42" 8" column
- 1710* Square Profile, 24" x 24" x 42" 10" column
- 1712* Square Profile, 24" x 24" x 42" 12" column

Product Features:

- Protection for warehouse and factory beams and columns
- 100% high density polyethylene protectors
- Fits 4", 6", 8", 10", and 12" round or square supports
- Resistant to most chemicals and feature key-lock to prevent slippage and assist installation alignment
- Two halves attach with easy-to-install straps. Yellow w/black straps, orange and lime w/Hi-Vis reflective straps
- All are UV protected
- Indicate color codes: Yellow (Y), Orange (OR), Lime (LM)

*Please specify color



1704
 4"-6" V-profile
 (Yellow Only)

SAFETY Ramps



Poly Curb Ramp
 1794 Yellow, 27" x 27" x 4"
Product Features:

- Use with hand trucks or wheel carts
- Safe and ergonomically correct method to move heavy loads (up to 1,000 lbs) over curbs or steps
- The raised non-slip surface w/ 1" side rails provide excellent traction
- High visibility safety yellow HDPE
- Lightweight (9 lbs.) ramp has 2 handles with rounded edges for easy pick-up, carrying and handling



Poly Ramp for Drum Platforms & Pallets
 1689 Yellow, 45 1/2" x 32" x 8"

Product Features:

- Use with hand trucks or wheel carts
- Safe and ergonomically correct method to move heavy loads (up to 1,500 lbs)
- The raised non-slip surface provides excellent traction
- Connects to the Modular Platforms 1632, 1633, 1634 and the Containment Platforms 1647, 1686 and 1688 (pages 11-13)

Narrow Column Protectors

- 1704 V-Profile, (Yellow only), 13" x 13" x 42", 4" - 6" column

Product Features:

- Protection for warehouse and factory beams and columns
- Absorbs impact from tow motors, minimizing column, fork truck, and personnel injury
- 100% high density polyethylene protectors
- Fits 4"- 6" round or square supports
- Resistant to most chemicals and feature key-lock to prevent slippage and assist installation alignment
- Two halves attach with easy-to-install straps
- All are UV protected
- Yellow only

LETTER from the PRESIDENT

In 2002, with 100 years of my family's tradition of excellence behind it, Strike First Corporation of America was launched in the United States by myself and Angie, my wife. The same quality and attention to details that is the hallmark of the Williams family products follows suit with Strike First Corporation of America. With myself at the helm, we continue to grow internationally as the direct result of our determination to listen to our customer's needs, improve the product accordingly, and remain competitive on pricing; all this while maintaining the highest and most consistent quality.

The fire prevention business in the 21st century is one that requires broad-based knowledge of the industry and constant customer contact. We continue to accomplish that in this competitive environment

while offering the solid foundation, based on years of experience in the fire protection industry, that allows our customers to rest assured that we strive only for the best.

It is our privilege to carry on the tradition of the Williams family here in the United States. Because the Williams family has always demanded the best of me, you can know with confidence that I will offer my best to you.



George K. E. Williams, *President*



**Check out our sister company,
Williams Brothers Corporation
of America,
Access Door and
Roof Hatch Division**



Corporate Office, 1330 Progress Drive, Front Royal, VA 22630



Western Distribution Center, 4058 S. McCarran Blvd., Bldg. A. Reno, NV 89502

**Strike First
Corporation
of America**

Distributed by
www.Ameraproducts.com

Phone: (800) 608-6568

Fax: (409) 840-5545

info@ameraproducts.com

SPECIFICATION GUIDELINES

HOW TO SPECIFY YOUR CABINET Follow the steps on each product page:

- Choose the Extinguisher Size (1)
- Choose the Cabinet Style (2)
- Choose the Door Style (3)
- Choose the Appropriate Series (4)
- Choose the Cabinet Type (5)
- Choose the Options listed below (6-9)

ORDERING PROCEDURE

Model Numbers - Fire Extinguisher Cabinets

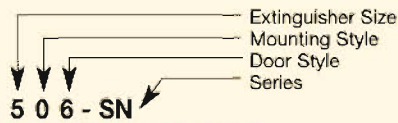

Specify SG when fire-rated

- (1) Extinguisher Size:5 = 5lb
 1 = 10lb
 2 = 20lb
- (2) Cabinet Style:0 = Surface (S)
 1 = Semi-Recessed (SR)
 2 = Fully-Recessed (FR)
- (3) Door Style:6 = Full Glass (FG)
 7 = Full Metal (FM)
 8 = Vertical Duo (VD)
 9 = Center Duo (CD)
 10 = Horizontal Duo (HD)
- (4) Series:EL = Elite Series
 BC = Bubble Series
 SN = Sonoma Series
 VC = Valve Series
 TN = Titan Series Aluminum
- (5) Cabinet Type: **SG = SAFEGUARD** (fire rated)

Options

- (6) Finish Options:.....SSF = Stainless Steel Front
 FSS = Full Stainless Steel
 AL = Aluminum Front (w/steel tub)
 FAL = Full Aluminum (front and tub)
 RD = Red Coated
- (7) Handle Options:.....008 = Safety Break Lock
 009 = Center Duo Safety Lock
 010 = Aluminum Die Cast Red
 "Fire" Handle
 012 = ADA Handle
- (8) Glazing:G10 = Double Strength Glass
 G11 = Clear Acrylic (Standard)
 G12 = Clear Tempered Glass
 G13 = Single Strength Glass
- (9) Lettering*:003 = Decal "Fire Ext." Sm Vert R/B
 004 = Decal "Fire Ext." Lrg Vert R/B
 005 = Decal "Fire Ext." Sm Horiz R/B
 006 = Decal "Fire Ext." Lrg Horiz R/B
 *Please indicate Red or Black lettering.



Full Glass (style 6)
ELITE Series



Red Coat Option
ELITE Series



Full Metal (style 7)
SONOMA Series



Center Duo (style 9)
ELITE Series



Vertical Duo (style 8)
ELITE Series



Aluminum Full Glass (style 6)
TITAN Series



Bubble Canopy (BC)



Classic Series
White



Plastic Cabinet
Red or White

IMPORTANT INFORMATION

PLEASE NOTE: We have made every effort to make this catalog complete and accurate. We reserve the right to make changes at any time, without notice, in prices, materials, equipment, specifications, models and availability. Specifications, dimensions, measurements, and other numbers in this catalog and other printed materials provided regarding these products are approximates based upon design and engineering drawings and prototypes. Your specific cabinet may differ slightly due to variations in manufacturing and equipment. In addition, some information may have been updated since the time of printing. Please contact customer service for complete details on all products

CABINET MEASURING GUIDELINES

Fire Rating Assembly

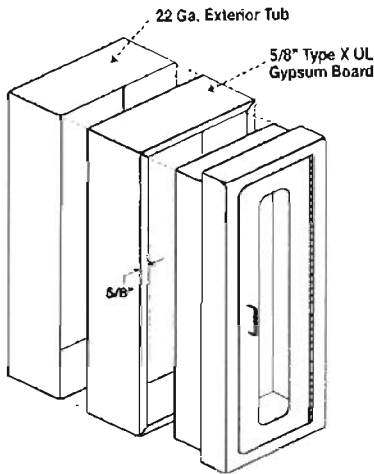

How to Measure a Cabinet

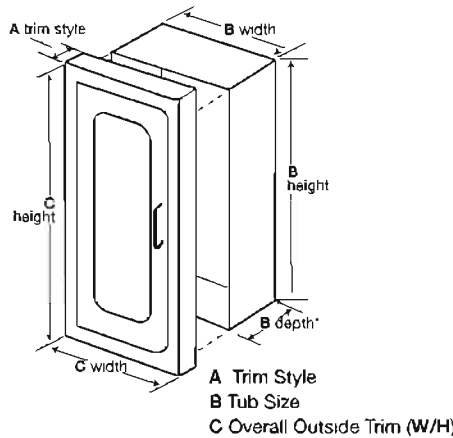

SONOMA Series Fire Rating Assembly

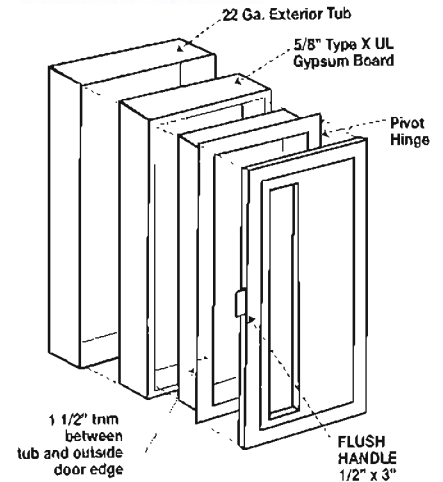

Non-Rated

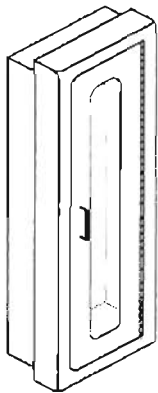

ELITE Series cabinet fronts are 16 gauge cold rolled steel with 22 gauge cold rolled steel tubs. Features full length piano type hinge.

Rough opening for all cabinets should be 1/4" larger than actual tub size.

Trim Style measurement varies depending on the type and size of cabinet. **ELITE** series semi-recessed is 1 1/2" for 5lb., 2 1/2" for 10lb., and 3" for 20lb. Fully recessed is 1/4" for all sizes. **ELITE** series fire rated semi-recessed is 1 1/2" for 5lb., 3" for 10lb., and 4" for 20lb. Fire-rated fully recessed is 1/4" for all sizes. **TITAN** series aluminum cabinets are only available in the 10lb with the same trim sizes as the **ELITE** series. **SONOMA** series cabinets are all trimless.

For more information on measuring and specifying the size of cabinet you need, contact our customer service department.

SONOMA Series Non-Rated

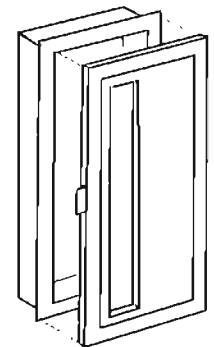

SONOMA Series cabinets are fully recessed and have a concealed hinge.

INSTALLATION OPTIONS

Installs in concrete, masonry, wood, and metal stud walls

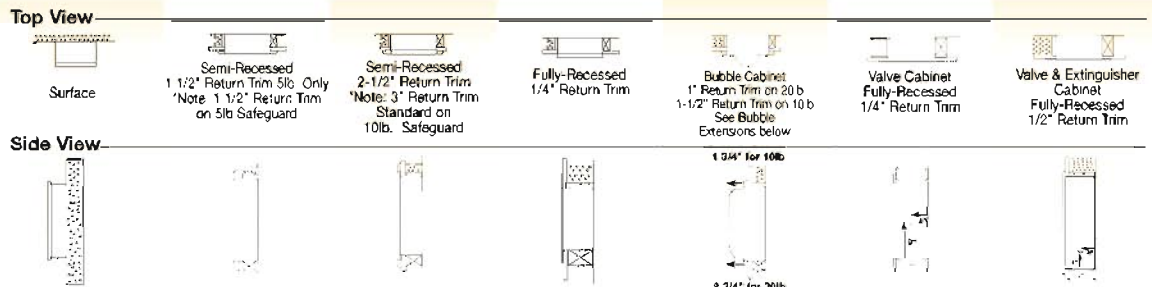

FIRE-RATED INSTALLATION GUIDELINE



UL Classified 5/8" Type X gypsum board inserted in the cavity between the two layers. Warnock Hersey has approved the Safeguard Cabinets to be mounted in any face of fire rated steel or wood stud for up to 2 hour rated walls without affecting its fire rating. The above meets the requirement test ASTM-E119-98 with test report WHI-495-1534. **MOUNTING INSTRUCTIONS** are supplied with each safeguard cabinet.

SAFEGUARD

Typical Semi-Recessed Fire Rated Installation

ONE HOUR FIRE WALL SYSTEM

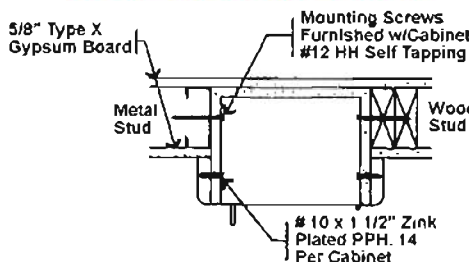

TWO HOUR FIRE WALL SYSTEM

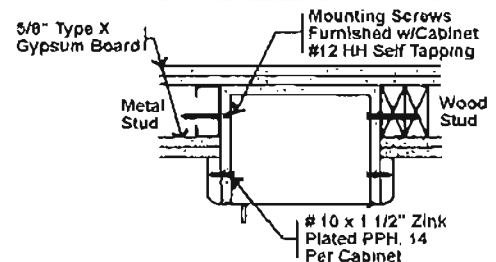

EL-ELITE ARCHITECTURAL Series Fire Extinguisher Cabinets

Distributed by
www.Ameraproducts.com
 Phone: (800) 608-6568
 Fax: (409) 840-5545
 info@ameraproducts.com

ELITE (EL) cabinet fronts are 16 gauge cold rolled steel with 22 gauge cold rolled steel tubs. Fronts are baked white enamel over rust inhibiting phosphate treated steel. All semi-recessed fronts have radius corners except the Apex 5lb cabinets have a 1 1/2" square trim. Stainless steel fronts come standard with white steel tubs. For full aluminum cabinets see page 7. All cabinets come standard with chrome handles and clear acrylic glazing.

SPECIFICATION PROCESS: Follow the steps below to specify your cabinet. See detail legend on page 3.

STEP 1: EXTINGUISHER SIZE:
 5 - 5 lb. 1 - 10 lb. 2 - 20 lb.

STEP 2: CABINET STYLE:
 0 - Surface Mounted (S)
 1 - Semi-Recessed (SR)
 2 - Fully-Recessed (FR)

STEP 3: DOOR STYLE:
 6 - Full Glass (FG)
 7 - Full Metal (FM)
 8 - Vertical Duo (VD)
 9 - Center Duo (CD)
 10 - Horizontal Duo (HD)

STEP 4: SERIES:
 EL - Elite

STEP 5: CABINET TYPE:
SG - SAFEGUARD - Fire Rated

STEP 6: FINISH OPTIONS:
 SSS - Stainless Steel Front

FSS - Full Stainless Steel
RD - Red Coated

STEP 7: HANDLE OPTIONS:
 008 - Safety Break Lock
 009 - Center Duo Safety Lock
 010 - Alum. Die Cast Red "Fire" Handle
 012 - ADA Handle 
 (see page 2 for guidelines)

STEP 8: GLAZING:
 G10 - Double Strength Glass
 G11 - Clear Acrylic (Standard)
 G12 - Clear Tempered Glass
 G13 - Single Strength Glass

STEP 9: LETTERING:
 002 - Decal "Pull Firmly" R only
 003 - Decal "Fire Ext." Sm Vert R/B
 004 - Decal "Fire Ext." Lrg Vert R/B
 005 - Decal "Fire Ext." Sm Horiz R/B
 006 - Decal "Fire Ext." Lrg Horiz R/B



Mod. #	Interior Tub Size			Overall Outside Trim		NON-RATED Rough Opening			NON-RATED Trim Style	SAFEGUARD Rough Opening 			SAFEGUARD Trim Style	Accom. Ext Size	
	W	H	D	W	H	W	H	D	W	H	D	W	H	D	Lbs.
Surface Mounted															
506-EL	8"	16 3/4"	5"	8 1/2"	17 1/2"	-	-	-	-	-	-	-	-	-	5
507-EL	8"	16 3/4"	5"	8 1/2"	17 1/2"	-	-	-	-	-	-	-	-	-	5
508-EL	8"	16 3/4"	5"	8 1/2"	17 1/2"	-	-	-	-	-	-	-	-	-	5
106-EL	9 1/2"	23 3/4"	6"	10"	24 1/2"	-	-	-	-	-	-	-	-	-	10
107-EL	9 1/2"	23 3/4"	6"	10"	24 1/2"	-	-	-	-	-	-	-	-	-	10
108-EL	9 1/2"	23 3/4"	6"	10"	24 1/2"	-	-	-	-	-	-	-	-	-	10
206-EL	12"	27"	8"	12 1/2"	27 1/2"	-	-	-	-	-	-	-	-	-	20
207-EL	12"	27"	8"	12 1/2"	27 1/2"	-	-	-	-	-	-	-	-	-	20
208-EL	12"	27"	8"	12 1/2"	27 1/2"	-	-	-	-	-	-	-	-	-	20
Semi-Recessed															
516-EL	8"	17"	5"	10 3/4"	19 3/4"	8 1/4"	17 1/4"	3 1/2"	1 1/2"	9 3/4"	18 3/4"	4"	1 1/2"	-	5
517-EL	8"	17"	5"	10 3/4"	19 3/4"	8 1/4"	17 1/4"	3 1/2"	1 1/2"	9 3/4"	18 3/4"	4"	1 1/2"	-	5
518-EL	8"	17"	5"	10 3/4"	19 3/4"	8 1/4"	17 1/4"	3 1/2"	1 1/2"	9 3/4"	18 3/4"	4"	1 1/2"	-	5
116-EL	9 1/2"	24"	6"	13 1/2"	28 1/2"	9 3/4"	24 1/4"	3 1/2"	2 1/2"	11 1/4"	25 3/4"	3 3/4"	3"	-	10
117-EL	9 1/2"	24"	6"	13 1/2"	28 1/2"	9 3/4"	24 1/4"	3 1/2"	2 1/2"	11 1/4"	25 3/4"	3 3/4"	3"	-	10
118-EL	9 1/2"	24"	6"	13 1/2"	28 1/2"	9 3/4"	24 1/4"	3 1/2"	2 1/2"	11 1/4"	25 3/4"	3 3/4"	3"	-	10
216-EL	12"	27"	8"	16"	31"	12 1/4"	27 1/4"	5"	3"	13 1/2"	28 3/4"	4 3/4"	4"	-	20
217-EL	12"	27"	8"	16"	31"	12 1/4"	27 1/4"	5"	3"	13 1/2"	28 3/4"	4 3/4"	4"	-	20
218-EL	12"	27"	8"	16"	31"	12 1/4"	27 1/4"	5"	3"	13 1/2"	28 3/4"	4 3/4"	4"	-	20
Fully-Recessed															
526-EL	8"	16 3/4"	5"	12"	21"	8 1/4"	17 1/4"	4 3/4"	1/4"	9 3/4"	18 3/4"	5 1/2"	1/4"	-	5
527-EL	8"	16 3/4"	5"	12"	21"	8 1/4"	17 1/4"	4 3/4"	1/4"	9 3/4"	18 3/4"	5 1/2"	1/4"	-	5
528-EL	8"	16 3/4"	5"	12"	21"	8 1/4"	17 1/4"	4 3/4"	1/4"	9 3/4"	18 3/4"	5 1/2"	1/4"	-	5
126-EL	9 1/2"	24"	6"	14"	28 1/2"	9 3/4"	24 1/4"	5 3/4"	1/4"	11 1/4"	25 3/4"	6 1/2"	1/4"	-	10
127-EL	9 1/2"	24"	6"	14"	28 1/2"	9 3/4"	24 1/4"	5 3/4"	1/4"	11 1/4"	25 3/4"	6 1/2"	1/4"	-	10
128-EL	9 1/2"	24"	6"	14"	28 1/2"	9 3/4"	24 1/4"	5 3/4"	1/4"	11 1/4"	25 3/4"	6 1/2"	1/4"	-	10
226-EL	12"	27"	8"	16"	31"	12 1/4"	27 1/4"	7 3/4"	1/4"	13 1/2"	28 3/4"	8 1/2"	1/4"	-	20
227-EL	12"	27"	8"	16"	31"	12 1/4"	27 1/4"	7 3/4"	1/4"	13 1/2"	28 3/4"	8 1/2"	1/4"	-	20
228-EL	12"	27"	8"	16"	31"	12 1/4"	27 1/4"	7 3/4"	1/4"	13 1/2"	28 3/4"	8 1/2"	1/4"	-	20

SN-SONOMA Series Extinguisher and Valve Cabinets



SONOMA Series (SN) cabinet fronts are 18 gauge cold rolled steel with 22 gauge cold rolled steel tubs, are fully recessed and have a concealed hinge. The Sonoma's aesthetically clean and trim appearance blends in with any decor. The cabinet design and appearance is superior for use in ultra modern interior designed commercial facilities. All Sonoma cabinets come standard with flush Sonoma handle.

- SPECIFICATION PROCESS:** Follow the steps below to specify your cabinet. See detail legend on page 3.
- STEP 1: EXTINGUISHER SIZE:**
1 - 10 lb. 2 - 20 lb.
 - STEP 2: CABINET STYLE:**
2 - Fully-Recessed (FR)
 - STEP 3: DOOR STYLE:**
7 - Full Metal (FM)
8 - Vertical Duo (VD)
 - STEP 4: SERIES:**
SN - Sonoma Cabinet
VC - Valve Cabinet
 - STEP 5: CABINET TYPE:**
SG - SAFEGUARD - Fire Rated
 - STEP 6: FINISH OPTIONS:**
SSF - Stainless Steel Front
FSS - Full Stainless Steel
BT - Black Tub
 - STEP 7: HANDLE OPTIONS:**
013 - Sonoma Stainless Steel Flush Handle (Standard)
 - STEP 8: GLAZING:**
G10 - Double Strength Glass
G11 - Clear Acrylic (Standard)
G12 - Clear Tempered Glass
G13 - Single Strength Glass
 - STEP 9: LETTERING:**
004 - Decal "Fire Ext." Lrg Vert R/B

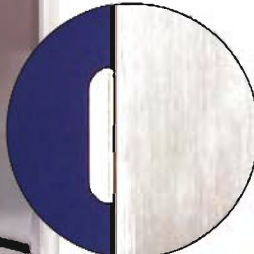

Flush handle is 1/2" x 3"

127-SN-SSF

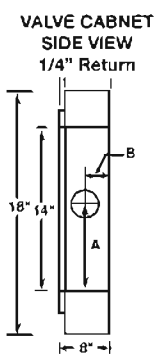

SAFEGUARD Valve Knockout
Drilling: No knockouts are provided with Sonoma Safeguard Valve Cabinets. Find the exact location of the pipe(s) which enter the cabinet and mark the cabinet tub appropriately. Both outside and inside tubs and insulation material must be completely open to receive pipe(s).



VC-SN



128-SN

Mod. #	Trim Style	Interior Tub Size			Overall Outside Trim		NON-RATED Rough Opening			SAFEGUARD Rough Opening			Knockout Location	Accom. Ext Size	
		W	H	D	W	H	W	H	D	W	H	D			A
Fully-Recessed															
127-SN	trimless	9 1/2"	24"	6"	13 1/4"	27 3/4"	9 3/4"	24 1/4"	5 3/4"	11 1/2"	26"	6 3/4"	-	10	
128-SN	trimless	9 1/2"	24"	6"	13 1/4"	27 3/4"	9 3/4"	24 1/4"	5 3/4"	11 1/2"	26"	6 3/4"	-	10	
227-SN	trimless	12"	27"	8"	15 3/4"	30 3/4"	12 1/4"	27 1/4"	7 3/4"	13 1/2"	28 3/4"	8 3/4"	-	20	
228-SN	trimless	12"	27"	8"	15 3/4"	30 3/4"	12 1/4"	27 1/4"	7 3/4"	13 1/2"	28 3/4"	8 3/4"	-	20	
Valve Cabinet														Angle Valve	
VC-SN	trimless	18"	18"	8"	20 3/4"	20 3/4"	19 1/4"	18 1/4"	8"	20"	20"	9"	9"	4"	2 1/2"

TN-TITAN Series Aluminum Extinguisher Cabinets

Titan Series (TN) Aluminum cabinets are constructed of non-extruded .063 thick aluminum with grey finish powder coat. All non-rated cabinets come standard with aluminum tubs, chrome steel handles and clear acrylic glazing. Fire-rated cabinets come standard with steel tubs, chrome steel handles and clear acrylic glazing.



SPECIFICATION PROCESS: Follow the steps below to specify your cabinet.

STEP 1: EXTINGUISHER SIZE:
 1 - 10 lb.

STEP 2: CABINET STYLE:
 0 - Surface Mounted (S)
 1 - Semi-Recessed (SR)
 2 - Fully-Recessed (FR)

STEP 3: DOOR STYLE:
 6 - Full Glass (FG)
 7 - Full Metal (FM)
 8 - Vertical Duo (VD)

STEP 4: SERIES:
 TN - Aluminum Cabinet

STEP 5: CABINET TYPE:
SG - SAFEGUARD - Fire Rated with steel tub

STEP 6: FINISH OPTIONS:
 AL - Aluminum Front (w/steel tub)
 FAL - Full Aluminum (front and tub)

STEP 7: HANDLE OPTIONS:
 008 - Safety Break Lock
 010 - Alum. Die Cast Red "Fire" Handle
 012 - ADA Handle 

STEP 8: GLAZING:
 G10 - Double Strength Glass
 G11 - Clear Acrylic (standard)
 G12 - Clear Tempered Glass
 G13 - Single Strength Glass

STEP 9: LETTERING:
 002 - Decal "Pull Firmly" R only
 004 - Decal "Fire Ext." Lrg Vert R/B
 005 - Decal "Fire Ext." Sm Horiz R/B
 006 - Decal "Fire Ext." Lrg Horiz R/B

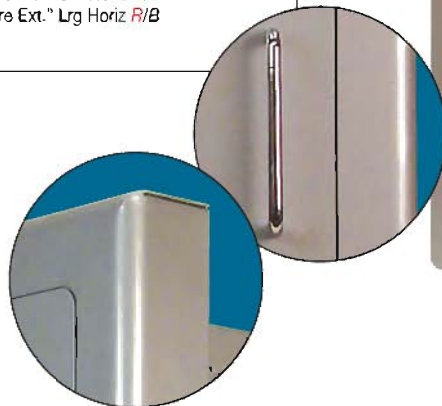

Return trim is a rolled edge, polished to a smooth finish.

116-TN

Mod. #	Interior Tub Size			Overall Outside Trim		FAL (aluminum front and tub) Rough Opening			FAL (aluminum front and tub) Trim Style	SAFEGUARD - AL (aluminum front and steel tub) Rough Opening 			SAFEGUARD AL (aluminum front and steel tub) Trim Style	Accom. Ext Size
	W	H	D	W	H	W	H	D		W	H	D		Lbs.
Surface Mounted														
106-TN	9 1/2"	23 3/4"	6"	10"	24 1/2"	-	-	-	-	-	-	-	-	10
107-TN	9 1/2"	23 3/4"	6"	10"	24 1/2"	-	-	-	-	-	-	-	-	10
108-TN	9 1/2"	23 3/4"	6"	10"	24 1/2"	-	-	-	-	-	-	-	-	10
Semi-Recessed														
116-TN	9 1/2"	24"	6"	13 1/2"	28 1/2"	9 3/4"	24 1/4"	3 1/2"	2 1/2"	11 1/4"	25 3/4"	3 3/4"	3"	10
117-TN	9 1/2"	24"	6"	13 1/2"	28 1/2"	9 3/4"	24 1/4"	3 1/2"	2 1/2"	11 1/4"	25 3/4"	3 3/4"	3"	10
118-TN	9 1/2"	24"	6"	13 1/2"	28 1/2"	9 3/4"	24 1/4"	3 1/2"	2 1/2"	11 1/4"	25 3/4"	3 3/4"	3"	10
Fully-Recessed														
126-TN	9 1/2"	24"	6"	14"	28 1/2"	9 3/4"	24 1/4"	5 3/4"	1/4"	11 1/4"	25 3/4"	6 1/2"	1/4"	10
127-TN	9 1/2"	24"	6"	14"	28 1/2"	9 3/4"	24 1/4"	5 3/4"	1/4"	11 1/4"	25 3/4"	6 1/2"	1/4"	10
128-TN	9 1/2"	24"	6"	14"	28 1/2"	9 3/4"	24 1/4"	5 3/4"	1/4"	11 1/4"	25 3/4"	6 1/2"	1/4"	10

VC-Valve Series Cabinets

Valve (VC) cabinet fronts are 16 gauge cold rolled steel with 22 gauge cold rolled steel tubs and are available with a full metal or full glass door panel.



26-VC

SPECIFICATION PROCESS: Follow the steps below to specify your cabinet. See detail legend on page 3.

- | | | |
|--|--|---|
| STEP 1: EXTINGUISHER SIZE:
Not Applicable | STEP 4: SERIES:
VC - Valve Cabinet | STEP 7: HANDLE OPTIONS:
008 - Safety Break Lock |
| STEP 2: CABINET STYLE: *
2 - Fully-Recessed (FR) | STEP 5: CABINET TYPE:
SG - SAFEGUARD - Fire Rated | STEP 8: GLAZING:
G10 - Double Strength Glass
G11 - Clear Acrylic (Standard)
G12 - Clear Tempered Glass
G13 - Single Strength Glass |
| STEP 3: DOOR STYLE:
6 - Full Glass (FG)
7 - Full Metal (FM) | STEP 6: FINISH OPTIONS:
SSF - Stainless Steel Front
FSS - Full Stainless Steel
RO - Red Coated (VC-Standard) | STEP 9: LETTERING:
007 - Decal "Fire Department Valve" |

SAFEGUARD Valve Knockout Drilling: No knockouts are provided with Safeguard Valve Cabinets. Find the exact location of the pipe(s) which enter the cabinet and mark the cabinet tub appropriately. Both outside and inside tubs and insulation material must be completely open to receive pipe(s).

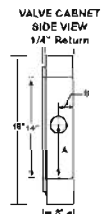

Mod. #	Interior Tub Size			Overall Outside Trim		NON-RATED Rough Opening			NON-RATED Trim Style	SAFEGUARD Rough Opening			SAFEGUARD Trim Style		Knockout Location		Accom. Ext. Size
	W	H	D	W	H	W	H	D		W	H	D			A	B	Lbs
Valve Cabinet Fully-Recessed																	
26-VC	18"	18"	8"	22"	22"	18 1/4"	18 1/4"	7 3/4"	1/4"	19 5/16"	19 5/16"	8 1/2"	1/2"		9"	4"	1 1/2 - 2 1/2
27-VC	18"	18"	8"	22"	22"	18 1/4"	18 1/4"	7 3/4"	1/4"	19 5/16"	19 5/16"	8 1/2"	1/2"		9"	4"	1 1/2 - 2 1/2

* Surface Mounted (S) is available upon request

BC-Bubble Canopy Series Cabinets



21-BC

Bubble Canopy (BC) cabinet fronts are 16 gauge cold rolled steel with 22 gauge cold rolled steel tubs. Cabinets offer a sleek design including a convex acrylic bubble door extending out from the trim, permitting 180° of visibility for quick identification of the extinguisher.

SPECIFICATION PROCESS: Follow the steps below to specify your cabinet. See detail legend on page 3.

- | | | |
|---|--|--|
| STEP 1: EXTINGUISHER SIZE:
1 - 10 lb. 2 - 20 lb. | STEP 4: SERIES:
BC - Bubble Cabinet | STEP 7: HANDLE OPTIONS:
008 - Safety Break Lock
010 - Alum. Die Cast Red "Fire" Handle
012 - ADA Handle (see page 2) |
| STEP 2: CABINET STYLE:
0 - Surface Mounted (S)
1 - Semi-Recessed (SR)
2 - Fully-Recessed (FR) | STEP 5: CABINET TYPE:
SG - SAFEGUARD - Fire Rated | STEP 8: GLAZING:
N/A - Bubble Only |
| STEP 3: DOOR STYLE:
N/A - Bubble Only | STEP 6: FINISH OPTIONS:
SSF - Stainless Steel Front
FSS - Full Stainless Steel
RD - Red Coated | STEP 9: LETTERING:
004 - Decal "Fire Ext." Lrg Vert R/B
006 - Decal "Fire Ext." Lrg Horiz R/B |

Mod. #	Interior Tub Size			Overall Outside Trim		NON-RATED Rough Opening			NON-RATED Trim Style	SAFEGUARD Rough Opening			SAFEGUARD Trim Style		Accom. Ext. Size
	W	H	D	W	H	W	H	D		W	H	D			Lbs.
Surface Mounted (Non-fire rated)															
10-BC	10 1/2"	24"	4 1/2"	11"	24 1/2"	-	-	-	-	-	-	-	-	-	10
Semi-Recessed															
11-BC	10 1/2"	23 3/4"	4 1/2"	14 1/2"	28"	10 3/4"	24 1/4"	3"	1 1/2"	12 1/4"	25 3/4"	3 3/4"	1 1/2"		10
21-BC	14"	30"	4 3/4"	18 1/2"	34"	14 3/4"	30 1/4"	4 1/4"	1"	16 1/4"	31 3/4"	5"	1"		20
Fully-Recessed															
12-BC	10 1/2"	24"	4 1/2"	14 1/2"	28"	10 3/4"	24 1/4"	4 1/2"	1/4"	12 1/4"	25 3/4"	5 1/4"	1/4"		10

Classic Series Cabinets

CLASSIC Series cabinets are an economical choice. 20 gauge cold rolled steel. These surface mounted and semi-recessed cabinets offer a clean appearance and come complete with breaker bar, safety locks, acrylic viewing panels and break glass decal.

SEMI-RECESSED
 999-SR (10 LB) ROUGH OPENING DIMENSIONS

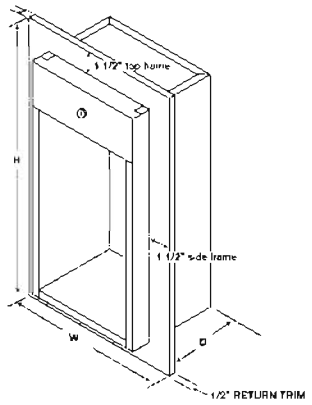

SURFACE
 (FOR 5, 10, AND 20 LB.)

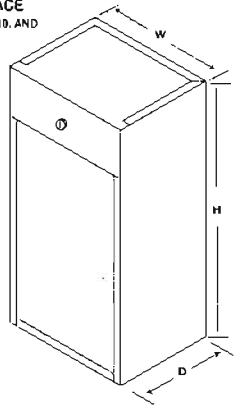

100
 Shown in optional red

Mod. #	Trim Style	Interior Tub Size			Overall Outside Trim		Rough Opening			Accom. Ext Size
		W	H	D	W	H	W	H	D	Lbs.
Surface Mounted										
100	-	8 3/4"	20"	5 3/4"	-	-	-	-	-	5
999	-	10 1/2"	24"	6"	-	-	-	-	-	10
104	-	13 3/4"	29 3/4"	8 3/4"	-	-	-	-	-	20
Semi-Recessed										
100-SR	-	8 3/4"	20"	5 3/4"	11 3/4"	23 1/8"	9 1/4"	20 3/4"	3 1/2"	5
999-SR	-	10 1/2"	24"	6"	13 3/4"	27 1/2"	10 3/4"	24 1/2"	3 1/2"	10

PC-Plastic Extinguisher Cabinets

Plastic (PC) Cabinets with body and frame injection molded in red or white virgin high-impact crystal polystyrene of .110 wall thickness with ultra-violet inhibitors, virgin acrylic Plaskolite® panel of .080 thickness. Chromium plated brass safety lock and key with weather-proof protective lock cover and polypropylene plastic injected molded hammer.



Mod. #	Trim Style	Interior Tub Size			Overall Outside Trim		With Cover Outside Opening			Carton Amt	Accom. Ext Size
		W	H	D	W	H	W	H	D		Lbs
Plastic Fire Extinguisher Cabinets											
PC-105-5	-	6"	16 3/4"	5 3/8"	8"	19"	8 1/4"	19 1/4"	6 3/4"	12	5 or 2 1/2
PC-105-10	-	6 3/4"	20 1/2"	6"	9"	23"	9 1/4"	23 1/4"	7 1/4"	10	10
PC-105-20	-	9"	26"	8"	11"	28"	11 1/2"	28 1/2"	9 1/2"	6	20